

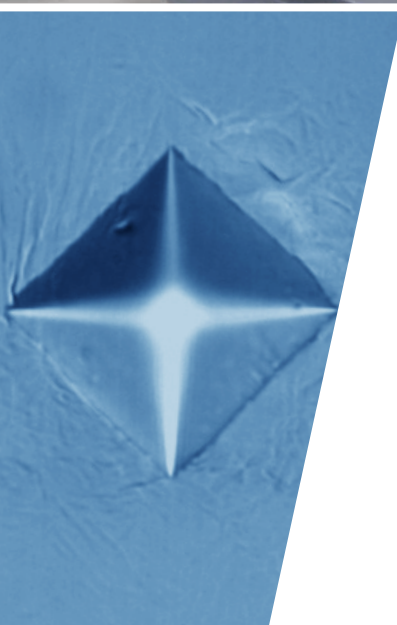

Wilson® VH3100

Automatic Vickers/Knoop Hardness Tester

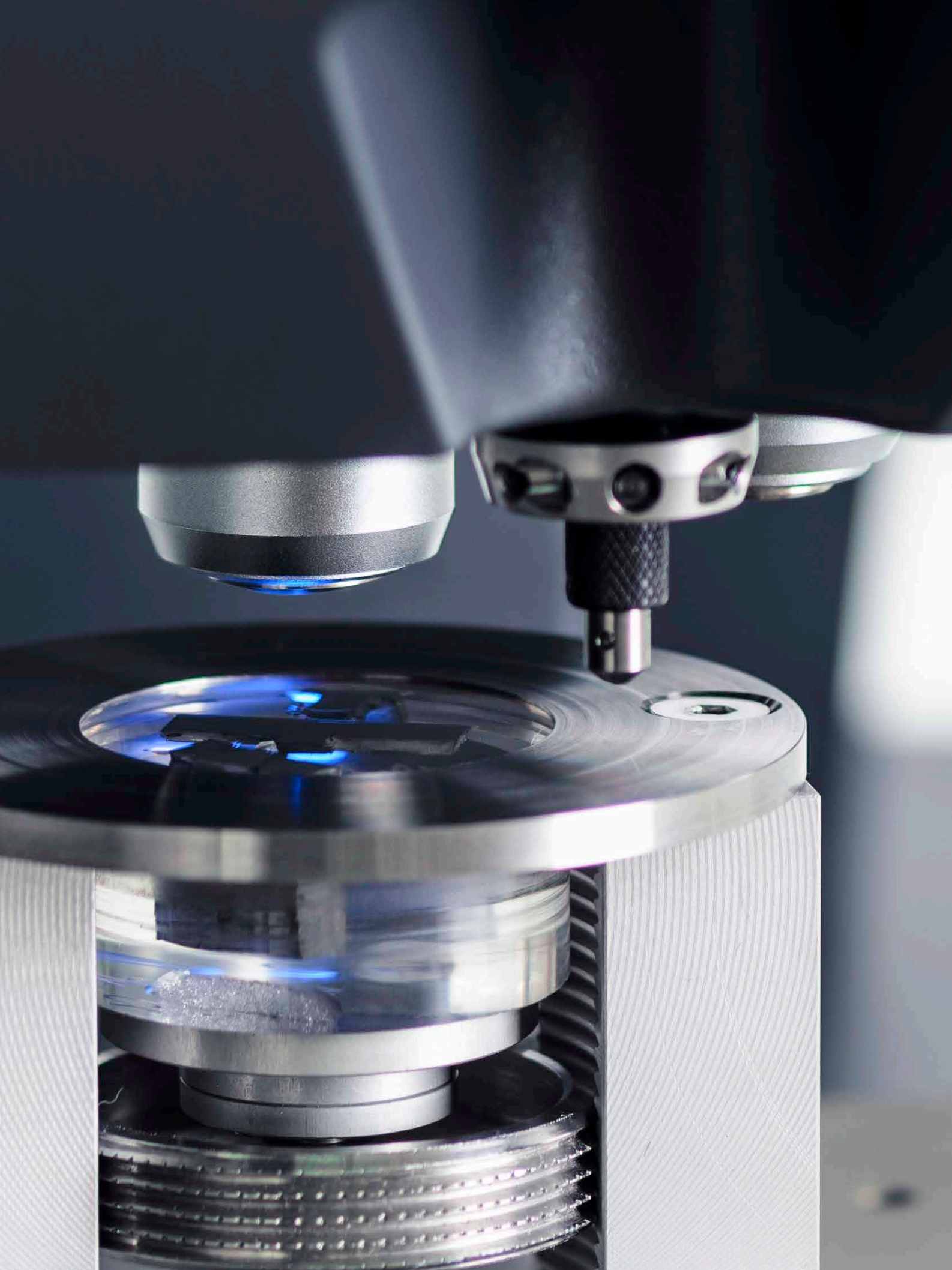



# Wilson® VH3100 Automatic Vickers/Knoop Hardness Tester

The Wilson VH3100 automatic Vickers/Knoop hardness tester is a revolutionary precision instrument that boasts a powerful test load range of 50gf - 10kgf, collision resistant system, and the most advanced optics in the industry. This unique combination allows the Wilson VH3100 to meet virtually any Vickers/Knoop testing requirement. Innovative digital zoom stepping provides the widest magnification range ever provided on a hardness tester. The addition of long working distance objectives and a high accuracy automated stage provide the basis for a truly powerful test system. All components and software are completely designed, manufactured, and integrated by Buehler.

*The Wilson VH3100 builds on the legacy of the Tukon 2500 and Reicherter KL4 hardness testers.*



## Load Range & Hardness Scales

	0.05kg	0.1kg	0.2kg	0.3kg	0.5kg	1kg	2kg	3kg	5kg	10kg
	HV0.05	HV0.1	HV0.2	HV0.3	HV0.5	HV1	HV2	HV3	HV5	HV10
	HK0.05	HK0.1	HK0.2	HK0.3	HK0.5	HK1				
						HB1/1	HB1/2.5		HB1/5	HB1/10



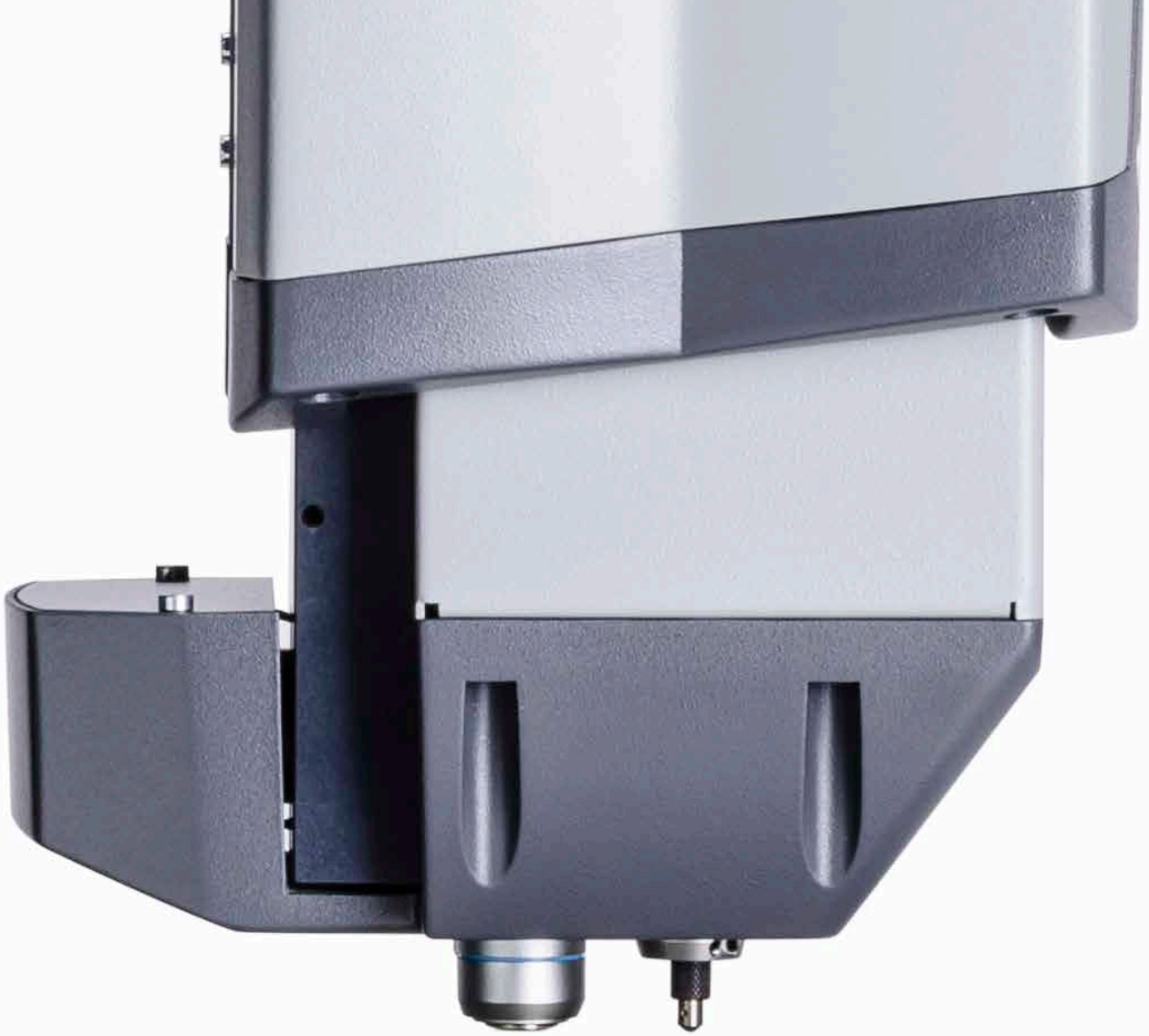

# Wilson® VH3100 Application Advantages

## Collision Resistant System for Indenter & Objective

The Collision Resistant System prevents indenter or objective damage by detecting unintended obstructions in the test path. The motion system is continuously monitored during the test process and system movement is instantaneously stopped if an obstruction is detected. The Collision Resistant System provides an unparalleled, unique to market essential safety benefit for operators, while reducing downtime and maintenance costs.



## Virtual Turret with Optional Overview Camera

The Wilson VH3100 significantly reduces system complexity with indenter, objectives and overview camera at fixed positions. All turret positioning is handled by the high-speed stage, while the test head stays stationary. The lack of moving parts, actuators and sensors, simplify adjustments and reduce service needs.

The optional built-in high resolution overview camera allows easy navigation over the specimen and accurately position indents.



## Increased Throughput

Save time with the Wilson VH3100 compared to other automated systems. Complete tasks in less time, or enjoy a higher throughput with one piece of equipment. The Wilson VH3100 is more than twice as fast compared to a traditional deadweight automatic Vickers/Knoop tester.

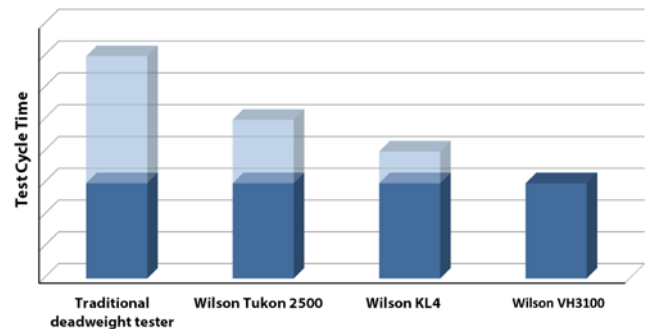

## Autofocus & Auto-Measure

Maintain productivity by using the standard auto-focus and auto-measure feature of the Wilson VH3100 enabling the operator to spend less time on these tedious tasks. The Auto-focus algorithm repeatedly generates infocus indentations, which can easily be measured without user intervention.

Manual positioning of filar-lines is no longer required with this refined measurement algorithm.

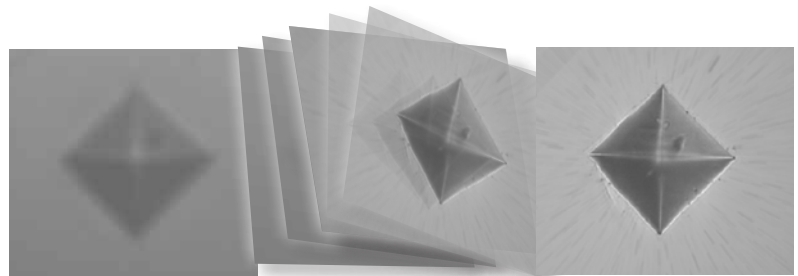

# Wilson® VH3100 Delivers

## Snap Grip

The indenter can be changed in seconds, and requires no tools or additional set-up.

By pre-aligning each indenter in its own snap-grip holder, changing indenters is simplified. Imagine installing a spare indenter or switching between Vickers and Knoop without any alignment effort.

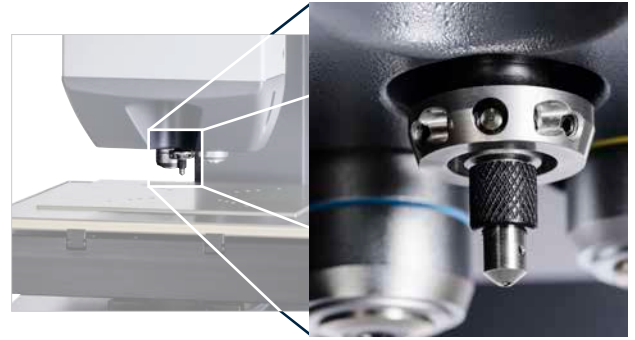

## Best in Class Optics Ensure Accurate Results

A precise indenting system is a critical requirement for a hardness tester, but must be paired with a system capable of accurately measuring the indentations.

This high quality optical system, with proprietary components, provides an unparalleled image, previously unavailable in hardness testing systems, providing the precision required for the most accurate measurements possible.



## Closed Loop Load Control

Fast, precise, and reliable testing with a sophisticated closed-loop electronic force measuring system and high precision "in-line" load application mechanics. With all critical parts on one axis and a minimization of moving parts, this closed loop control prevents load overshoot from happening, while compensating for friction and wear over time.

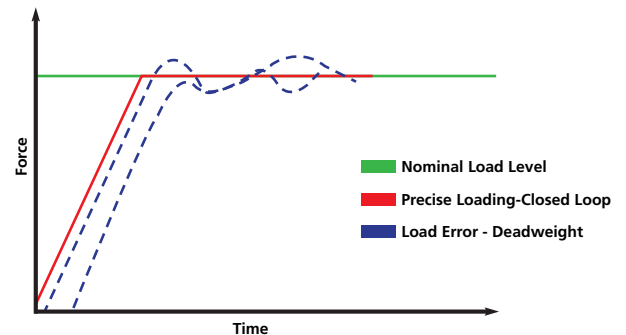

## Durable, Rugged Design

Elegant and compact design, yet durable and stable; that is what the Wilson VH3100 offers with its computer designed cast aluminum pedestal. Intense Finite Element Analysis (FEA) ensures that any form of indent plowing is completely eliminated. The full metal frame helps dampen vibrations.

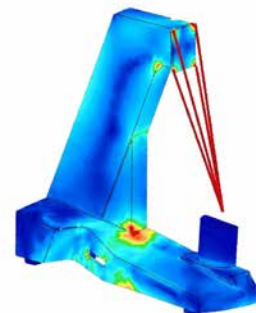

# Wilson® VH3100 Applications

## Separate Monitor or Integrated Touchscreen

The Wilson VH3100 offers the freedom of choice. For swift and easy “click and run” automated operation, use the rugged, high responsive touchscreen in a clean production environment. The large, conventional monitor options might be a more suitable solution for large amounts of reporting and result analysis.



## Choose a Frame Size

All hardness testing applications can be addressed with the three frame sizes offered. The compact model takes up little counter space while providing test capacity of 4.9in [125mm].

If larger vertical capacity is required, select the standard frame for up to 6.7in [170mm] or the large frame for samples up to 8.5in [215mm].



## Choose Magnification

The digital zoom function increases the range of each objective, thus allowing for complete coverage of applications with only 2 objectives. This saves money and time.

Both objective positions are monitored by the crash resistant system.

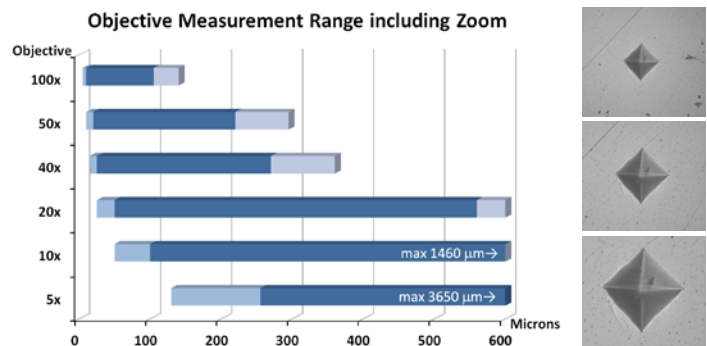

## High Velocity Stage

Save time and improve efficiency with one of the high speed motorized XY-stages. Choose the large stage with 7.1 x 7.1in [180 x 180mm] travel or upgrade to the Extra-large 11.8 x 7.1in [300 x 180mm] stage, and load multiple samples at once to test them in an automated sequence.

The high accuracy and repeatability guarantees precise positioning of indents, and allows re-evaluation of all measurement points of the current batch, using the live camera image.





# At a Glance



## Large Capacity

- Three different height options
- Up to 8.26in [210mm] vertical capacity

## Accurate & Flexible Load

- High precision closed loop system for 50gf - 10kgf load range

## Virtual Turret

- No moving parts in the test head means reduced error sources
- Two objectives with zoom ability and an optional overview camera

## Best in Class Optics

- Microscope quality optics
- Long working distance optics

## Fast & Accurate Stage

- Incredibly fast motorized stage with 5µm or better accuracy

## Connectability

- USB, Ethernet & External monitor connection

## Safety

- Resist breakage of an indenter or objective with the Collision Resistant System for indenter and objectives



# Wilson® VH3100 Automatic Vickers/Knoop Hardness Tester

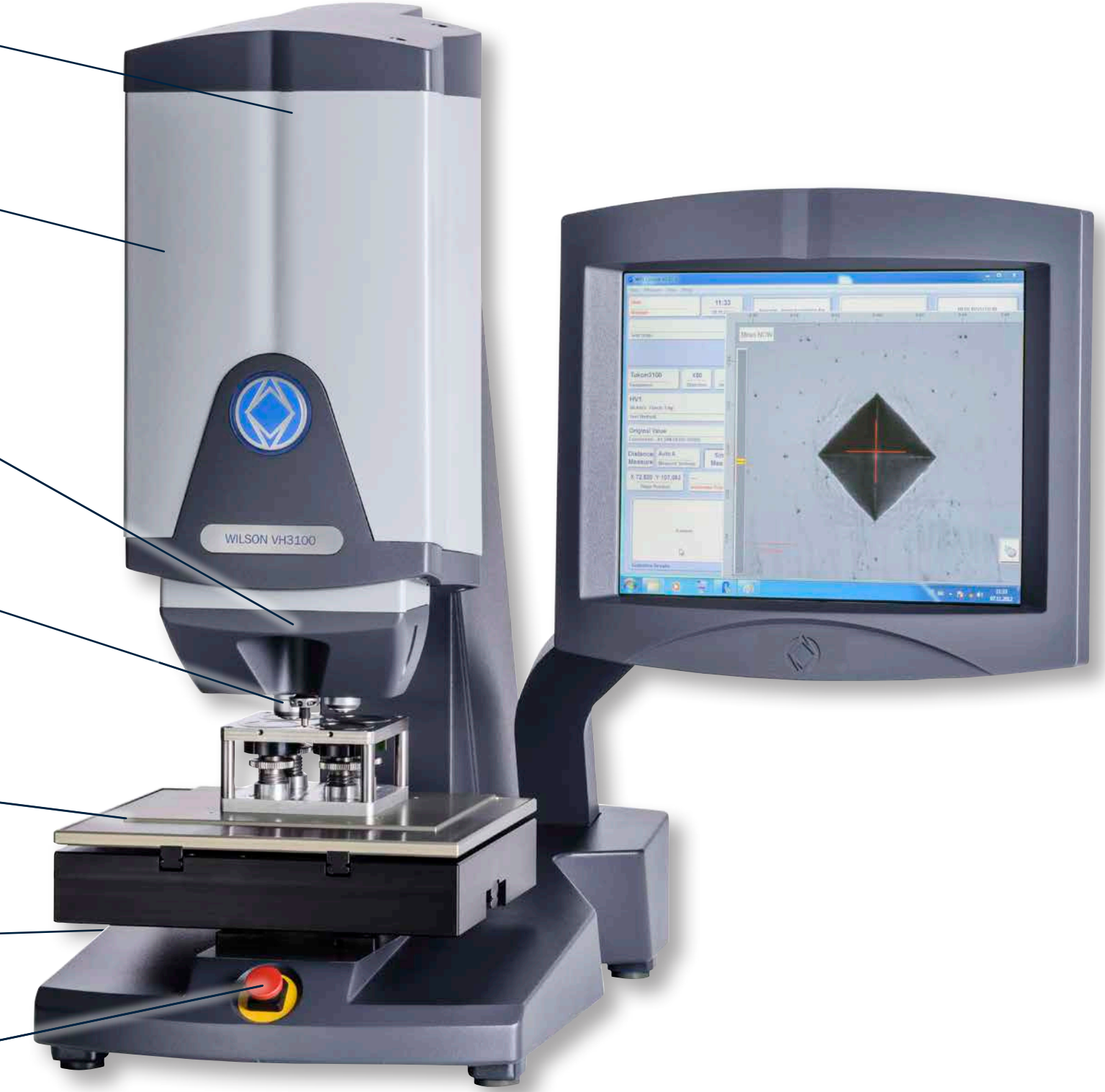

# Control & Evaluate Software

## Separate Monitor or Integrated Touchscreen

All control of the hardness instrument is handled through comprehensive software – automatically test and measure indentations, as well as set up and run automatic testing sequences with minimal operator interaction. All parameters of the test, such as load changes, dwell times, and focusing are controlled through the software making for a very user friendly system. Hardness scale conversions into other scales are supported.

The Wilson VH3100 measurement system completes a total package that is fast and easy to use. The automatic measurement feature not only reduces overall testing time, it also reduces operator errors common with manual measurements. The available software uses advanced imaging processes and algorithms that account for a variety of methods to simultaneously identify the indent borders, independent of the light settings, making the system extremely capable of accurately reading varying surfaces.



Left side mounted integrated touch screen

## User Defined Programs

Using a set of simple tools, users can customize test patterns in a program. Programs can be saved and used whenever required, edited, copied or amended. Pre-fabricated programs can be loaded and amended to suit a particular application. Save set-up time and improve positioning accuracy with these automatic testing sequences.

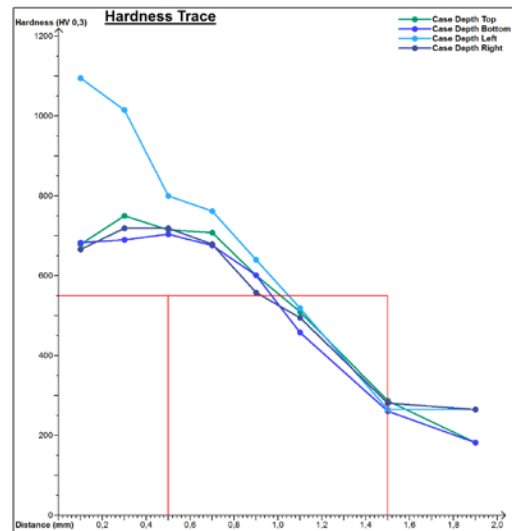
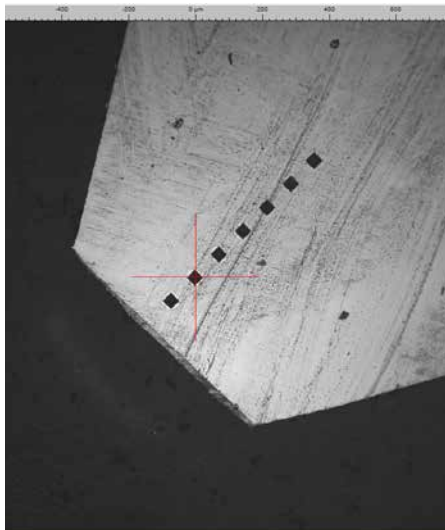

# Safely Document Results

Document readings in PDF or print them on paper.

## Recording

- Record the hardness value, reference number, distance, conversions, d1 & d2, coordinates and comments in clear tabular format

Grp	Pos	Distance	Hardness	Status	Pos X	Pos Y	Pos Z	Diag X	Diag Y	Ref	Comment
1	0	0.000	AMFANKSP1	OK	0.000	0.000	0.000	99999.9	0.0	0	0
1	1	0.200	396 HV 1	OK	0.306	-0.200	0.000	00.4	01.8	0	0
1	2	0.400	283 HV 1	OK	0.319	-0.393	0.000	00.0	01.8	0	0
1	3	0.600	322 HV 1	OK	0.319	-0.600	0.000	75.9	75.8	0	0
1	4	0.800	263 HV 1	OK	0.226	-0.793	0.000	02.3	64.5	0	0
1	5	1.000	177 HV 1	OK	0.322	-0.999	0.000	104.2	100.2	0	0
1	6	1.200	222 HV 1	OK	0.245	-1.200	0.000	96.3	92.2	0	0
1	7	1.400	162 HV 1	OK	0.105	-1.398	0.000	107.7	105.7	0	0
1	8	1.600	174 HV 1	OK	0.218	-1.398	0.000	105.2	100.7	0	0
1	9	1.800	166 HV 1	OK	0.304	-1.599	0.000	104.7	106.2	0	0
1	10	2.000	183 HV 1	OK	0.110	-1.798	0.000	99.8	101.6	0	0
1	11	2.200	182 HV 1	OK	0.257	-1.992	0.000	93.0	98.7	0	0
1	12	2.400	182 HV 1	OK	0.323	-2.192	0.000	101.2	99.9	0	0
1	13	2.600	211 HV 1	OK	0.126	-2.388	0.000	93.9	93.6	0	0
1	14	2.800	AMFANKSP1	OK	0.500	0.004	0.000	99999.9	0.0	0	0
2	0	0.000	AMFANKSP1	OK	0.500	0.004	0.000	64.6	62.9	0	0
2	14	0.200	456 HV 1	OK	0.588	-0.195	0.000	72.7	76.6	0	0
2	15	0.400	332 HV 1	OK	0.522	-0.402	0.000	70.9	79.5	0	0
2	16	0.600	299 HV 1	OK	0.557	-0.599	0.000	70.9	79.1	0	0
2	17	0.800	297 HV 1	OK	0.483	-0.805	0.000	87.9	90.0	0	0
2	18	1.000	234 HV 1	OK	0.282	-0.998	0.000	85.7	85.9	0	0
2	19	1.400	251 HV 1	OK	0.353	-1.443	0.000	85.7	85.9	0	0
2	20	1.800	142 HV 1	OK	0.729	-1.791	0.000	114.2	115.1	0	0
2	21	2.200	157 HV 1	OK						0	0

## Custom Header

- Create your own header with logo address and ID

**BUEHLER**  
An ITW Company

**VICKERS HARDNESS TEST**

**Buehler**  
Wilson Hardness  
Boschstrasse 10  
73734, Esslingen

Sample: Heatreatment  
Date: 11-1-2013  
Order Number: ACB-478-2013  
Tester: Dr\_Hardness

Batch number: 01457744-08  
Oven: 12B  
Temperature: 800°C  
Temperature 2: 700°C  
Alloy: Si37-2

Alloy 2: -  
Supervisor: R. Mayer  
Shift leader: O. Sahin  
Customer: VIP  
Part number: 01-778-887-5478

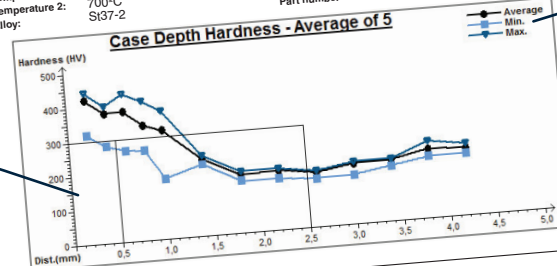

## Graphs

- Show one or more graphs to get a quick overview of your measurements

## Custom Fields

- Data fields can be defined and filled out during testing then printed on reports

## Templates

- Find the desired layout among various standard templates or create a custom template

Result  
CHD 300 HV 1 = 1,08 mm

Row	Point	Distance	Hardness	Conv Hardness 1	Comment
1	1	0.2000	396 HV 1	-	-
2	2	0.4000	283 HV 1	-	-
3	3	0.6000	322 HV 1	-	-
4	4	0.8000	263 HV 1	-	-
5	5	1.0000	177 HV 1	-	-
6	6	1.4000	222 HV 1	-	-
7	7	1.8000	162 HV 1	-	-
8	8	2.2000	174 HV 1	-	-
9	9	2.6000	166 HV 1	-	-
10	10	3.0000	183 HV 1	-	-
11	11	3.4000	182 HV 1	-	-
12	12	3.8000	224 HV 1	-	-
13	13	4.2000	211 HV 1	-	-

Row	Point	Distance	Hardness	Conv Hardness 1	Comment
14	14	0.2000	456 HV 1	-	-
15	15	0.4000	332 HV 1	-	-
16	16	0.6000	299 HV 1	-	-
17	17	0.8000	297 HV 1	-	-
18	18	1.0000	234 HV 1	-	-
19	19	1.4000	251 HV 1	-	-

## Results

- Results tables showing hardness values, converted values, diagonals, XY-locations and more

## Analyze, Evaluate, Process

The amount of measuring data generated as a result of high level automation is constantly increasing. This software provides a flexible solution to analyze and process data rapidly. A PDF report or Excel sheet can be generated with just a few mouse clicks, and can even be set to automatically run after each measurement.

# Vickers & Knoop Accessories

## Micro-Hardness Accessories

Choose from a comprehensive selection of micro-hardness accessories. From fixtures to test blocks, Buehler has everything you need to get the job done. Selection assistance can be provided by many of our experts.

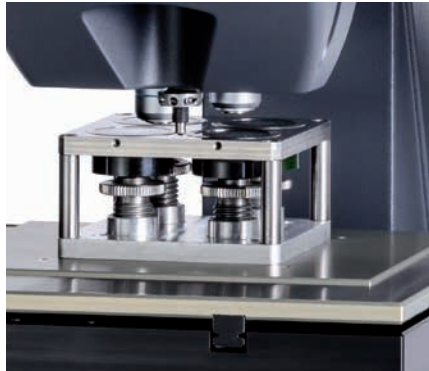

Multi-sample holder

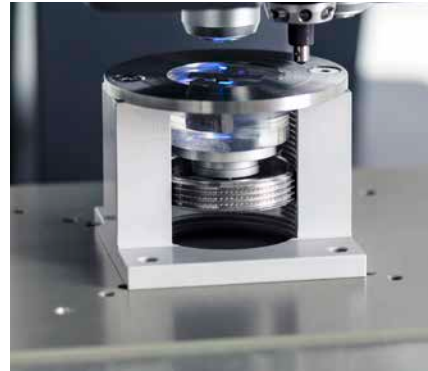

Single sample holder

## Choosing the Correct Support

It's important to keep the test specimen stationary during set-up and testing. The correct support will help ensure that the specimen remains motionless.

A wide range of supports are available, whether testing mounted samples, tapered pieces, small diameter parts, wires or sheet metal. Refer to the Buehler Product Catalogue to select the appropriate support for the application.

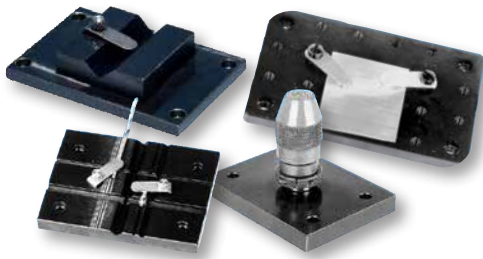

## Tip

Ensure that both the specimen and the support accessory are free of dirt, grindings, oil or corrosion. Only in this way are accurate and reliable results ensured.

For more background information on Vickers and Knoop testing, please refer to the most current edition of Buehler SumMet.



## Wilson® Test Blocks & Indenters

Wilson test blocks and indenters provided for a wide range of Vickers & Knoop, as well as Rockwell® and Brinell applications. Certified to a range of international standards including ASTM and ISO, we manufacture test blocks in-house to ensure the highest quality test reference standards available. Test blocks and indenters are certified using the latest standardization and optical measuring technology. We operate our own calibration laboratory, traceable to NIST and are accredited to ISO/IEC 17025 by A2LA®.



\* Model Tukon™ 300 and newer



## Modular Design

The Wilson® VH3100 was designed with ease of maintenance in mind. This has resulted in a plug and play modular design, where motorized stage, loadcell, controller and test head are easy to exchange in the field. A smart design in combination with tight production tolerances ensure that the modules can be integrated without significant mechanical adjustments. The Windows® based software platform is future proof, and maintained with regular updates.

The many years of experience in designing rugged hardness testers, combined with this new service friendly concept, will reduce downtime, contributing to overall productivity and keeping cost of ownership at a minimum.



## Certified

Built in the south of Germany in an accredited ISO 17025 calibration laboratory, the Wilson VH3100 is fully trained employees and certified process. Each machine comes with a detailed verification report, proving the outstanding quality. The calibration procedures form the strong base of our ISO 9001:2008 certified business processes.

For a traceable on-site calibration, please contact your local service representative.

## Service

Buehler is a worldwide leader in materials preparation and analysis. As your partner in all aspects, we provide not only a complete line of equipment and consumables, but a strong team dedicated to application knowledge, technical support, and when need be, service. With more than 80 locations across the globe offering telephone and email support, training courses, webinars, and one-on-one custom training, Buehler is there to offer support to our customers, industry and applications. Dedicated to your needs, we strive for fast consumable deliveries, efficient service support and 24/7 access to our online preparation guide.

**Service - US**  
(800) 283-4537  
service@buehler.com

**Service - Europe, Africa,  
Middle East**  
+49 (0)711 4904690  
europe.service@buehler.com

**Service - Asia-Pacific**  
+86 21 6476 6110  
asia.service@buehler.com

# Technical Specifications

## Hardness Tester Specifications

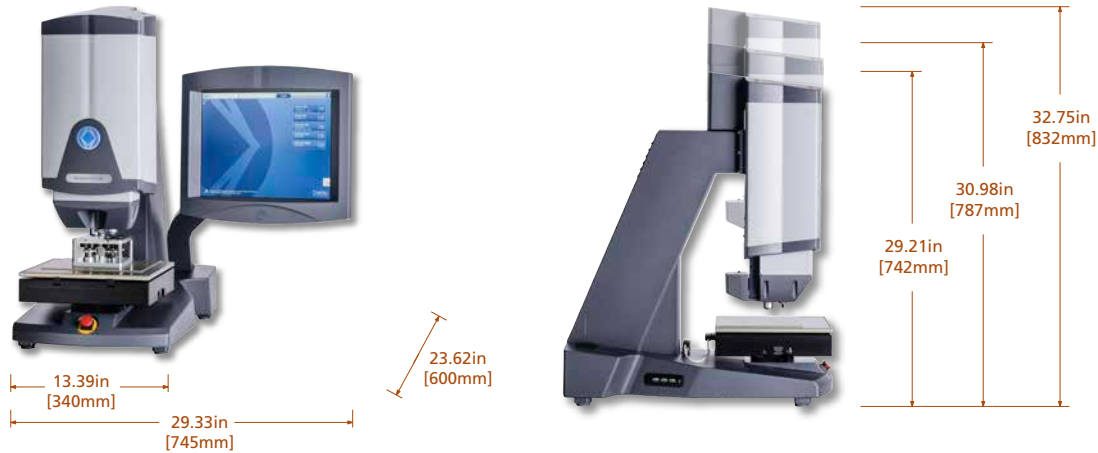

Approx. Weight: 82.7 lbs [37.5kg] *without monitor*  
 Approx. Monitor Weight: 11.5 lbs [5.2kg] *excluding arm*



Scales	HV, HK, HB
Test Load	50gf - 10kgf
Test Load Accuracy	±1.5% < 200g, ±1% > 200g
Force Application	Load Cell
Dwell Time	1 - 999 seconds
Standard Compliance	ASTM E384 & E92; ISO 6507, 9385, 4546
Turret	Automatic virtual turret
Magnification Range	30X - 2000X with digital zooming
Overview Camera <i>(optional)</i>	0.5 x 0.5in [13 x 13mm] or 0.78 x 0.78in [20 x 20mm]
Light Source	LED
Operating Temperature	50 - 100°F [10 - 38°C]
Humidity	10 - 90% non-condensing
Power	370VAC - 100-240VAC, 50/60Hz
Weight	82.7 lbs [37.5kg] <i>without monitor</i>

## Stage Option Specifications

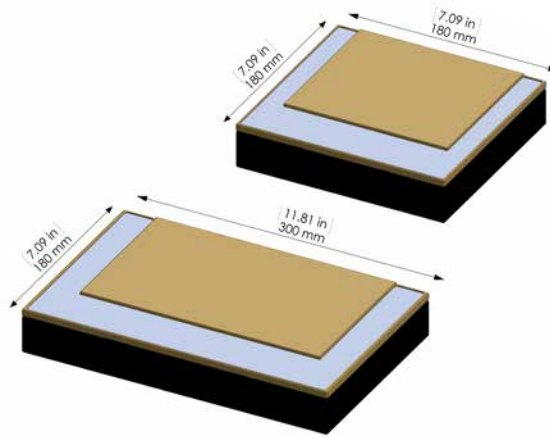

Travel & Workspace	<ul style="list-style-type: none"> <li>• Large Stage (L): Travel 7.08 x 7.08in [180 x 180mm] Effective workspace: 5.5 x 5.7in [140 x 145mm] (4.33in [110mm] with overview camera)</li> <li>• Extra Large Stage (XL): Travel 11.8 x 7.08in [300 x 180mm] Effective workspace: 10.23 x 5.7in [260 x 145mm] (4.33in [110mm] with overview camera)</li> </ul>
Travel Speed	1.06in/s [24mm/s] (XY)
Reproducibility	Better than 5µm
Weight	L Stage: ±22.0lb [±10kg] XL Stage: ±30.8 [±14kg]
Overall Size	L Stage: 11.02 x 10.23 x 2.75in [280 x 260 x 70mm] XL Stage: 15 x 10.23 x 2.75in [380 x 260 x 70mm]

## Software Specifications

Software Version	WinControl or Minuteman
Focus	Automatic Focus
Measurement	Manual or Automatic Indent Measurement
Stage Control	Auto traversing for various patterns: CHD, line, circle, matrix and others
Optional Features	Multi-sample

Buehler products are used throughout the world in manufacturing facilities, quality laboratories, and universities to analyze all types of materials, including:

- Aerospace
- Automotive
- Biomedical & Medical
- Ceramic, Plastics, Composites
- Education, Defense, Government
- Electronics & Optics
- Energy & Construction
- Petrography
- Primary Metals

#### Buehler Americas

- ★ Lake Bluff, IL, US Worldwide Headquarters
- Binghamton, NY, US
- Norwood, MA, US
- Whitby, ON, CA

#### Buehler Europe

- Coventry, UK
- Dardilly, FR
- Düsseldorf, DE
- Esslingen, DE



- Main Offices
- Manufacturing
- Sales
- Service
- Laboratory
- Distributors

#### Buehler Asia

- Hong Kong, CN
- Shanghai, CN

### Buehler Worldwide Locations

Other products from Buehler:



Sample preparation equipment includes: abrasive sectioning, precision cutting, mounting, grinding & polishing, electronics and petrography.



Consumables for sample preparation equipment include: abrasive wheels, precision blades, compression mounting compounds, castable systems, silicon carbide abrasive papers, diamond grinding discs, polishing cloths, diamond polishing suspensions, and final polishing suspensions.

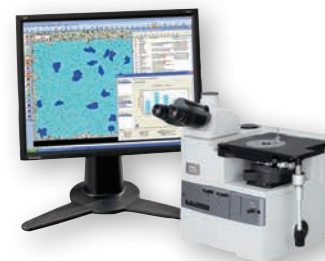

Imaging & analysis and hardness testing equipment include: microscopes, cameras, imaging & analysis software, hardness testers, fixtures, test blocks and hardness software.



Shop online at [www.buehler.com](http://www.buehler.com). (US, DE, FR and UK only)

For a complete listing of consumables, visit our website at [www.buehler.com](http://www.buehler.com) or refer our Product Catalogue. Buehler continuously makes product improvements; therefore technical specifications are subject to change without notice.

Sectioning AbrasiMet • AbrasiMatic • IsoMet	Mounting SimpliMet	Grinding & Polishing EcoMet • AutoMet • MetaServ	Imaging & Analysis OmniMet	Hardness Testing Wilson®
--	-----------------------	---	-------------------------------	-----------------------------



**BUEHLER Worldwide Headquarters**  
41 Waukegan Road  
Lake Bluff, Illinois 60044-1699 USA  
P: (847) 295-6500  
[www.buehler.com](http://www.buehler.com) | [info@buehler.com](mailto:info@buehler.com)

**BUEHLER Germany**  
[info.eu@buehler.com](mailto:info.eu@buehler.com)

**BUEHLER France**  
[info.fr@buehler.com](mailto:info.fr@buehler.com)

**BUEHLER United Kingdom**  
[info.uk@buehler.com](mailto:info.uk@buehler.com)

**BUEHLER Canada**  
[info@buehler.ca](mailto:info@buehler.ca)

**BUEHLER Asia-Pacific**  
[info@buehler.com.hk](mailto:info@buehler.com.hk)

**BUEHLER China**  
[china@buehler.com.hk](mailto:china@buehler.com.hk)